

Data Sheet

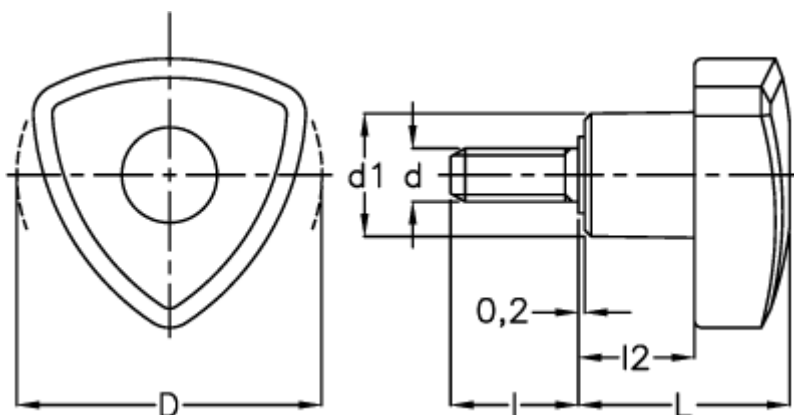

Article number: 2302083442
Description: E+G Lock knob
VTR.40 p-M6x20

Measures



d = 40
d1 = 16
d 6g = M6
l = 20
L = 30
l2 = 17